

Charles
County
Amateur Radio
Club

Inside this
issue:

Activities	6
ARES	10
Contests	16
Crossword/ puz-	17
Hamfest	5
Minutes	32
Practice questions	3
Special events	18

Smoke Signals



Volume 24
issue 9

September 2021

Meeting 3rd @ 1900 EST via Zoom &/or
Marbury Baptist Church 4670 Bicknell Rd,
Marbury, MD 20658

THE PRESIDENT'S WORKBENCH

The cusp of autumn is at hand. Daily high temperatures will, hopefully, become a bit more tolerable and evenings a bit cooler. The autumnal equinox will be on September 22, signaling the change to longer nights and shorter days.

On September 19, Jeff and Pam are once again hosting their annual Connector Workshop. In addition to the usual instruction and construction of Anderson Power-Pole cables and adapters, there will also be presentations on various solar power options. But wait, there's more! There will be a construction project to build a 3-element Quad antenna for use on the 2-meter band for those who get their request in by the deadline. As a special offer to CCARC members only, the deadline for ordering the antenna kit is extended to the end of our monthly meeting September 3- cost of the antenna kit is \$20. See flyer page 9 .

Often at our meetings, ideas are

suggested for activities that the club members might be interested in doing. These are not just ideas pulled from thin air but many times they are suggested by fellow members. I've noticed that recently the reception to the ideas has often been cool. Perhaps we're still gun shy about getting together due to the pandemic. I get it, believe me. But for those that suggest activity ideas, please don't let the cool receptions discourage you. In fact, I would really like to see you pursue your idea and post on the reflector, in the newsletter, or send an email explaining when, where and what you will be doing so others that might be interested in participating can connect with you. When you get together for the activity, please take photos, give us a brief synopsis of the activity and how it went. Again you can do that via the email reflector, but better still would be to send it to Michelle for the newsletter.

(Continued on page 2)

CALENDAR

September

01 Net 2030

03 meeting

08 Net 2030

15 Net 2030

19 Connector
Workshop

22 Net 2030 &
News articles due

29 Net 2030

October

01 meeting

06 Net 2030

13 Net 2030

20 Net 2030

27 Net 2030 &
News articles due

(Continued from page 1)

This month is also the 20th anniversary of the 9/11 terrorist attack on the World Trade Center and the Pentagon. There are three special event stations listed on the ARRL Special Event Calendar commemorating the events of that day. I'm sure we all remember where we were and what we were doing when the news broke of the horrific events. (Locally, Charles county victims of the attack will be remembered in a ceremony at the county government building at 9:30 AM.)

In addition to those three special event stations, there are 32 others covering a myriad of occasions. A few that caught my eye were the Blue Ridge Bonanza, Route 66 on the Air, and International Talk Like A Pirate Day. The first two are similar to the 13 Colonies special event with multiple stations for you to try to contact for a clean sweep. The third one is just a chance to get on the air and spend some time letting your hair down; think of it as happy hour at the bar but over the radio instead. Look through the September Special Event List elsewhere in this issue for dates, times and details.

For those needing some states for their Worked All States (WAS) award, there will be state QSO parties in September for Colorado, Tennessee, Alabama, Iowa, Texas, New Jersey, New Hampshire and Maine. Along with those, there will be State Parks on the Air events for Ohio and Wisconsin. Look in the contest calendar elsewhere in this issue for dates and times.

Speaking of contests, there are three in September that may be of interest. For our technician licensees, there is the ARRL September VHF/UHF contest that runs from 1800Z (2:00 PM local) on September 11, through 0300Z September 13 (11:00 PM local, September 12). For those that need some Asian stations for your DXCC, or other awards, there is the All Asian DX (phone) from 0000Z on September 4 (8:00 PM local, September 3) through 2400Z (8:00 PM local) on September 5. Look in the contest calendar elsewhere in this issue for dates, times and rules.

There's also a special contest for those that enjoy operating portable. It is the Portable Operations Challenge, which is in 3 sessions over 2 days, 4 hours for each session. For dates, times and rules visit <https://foxmikehotel.com/poc-rules-and-scoring/> .

Get on the air and exercise those operator privileges you worked so hard to earn.



by Bob, NW3M

Practice questions

1. What is the purpose of a gin pole?
 - A. To temporarily replace guy wires
 - B. To be used in place of a safety harness
 - C. To lift tower sections or antennas
 - D. To provide a temporary ground
2. What is component 4 in figure T1?

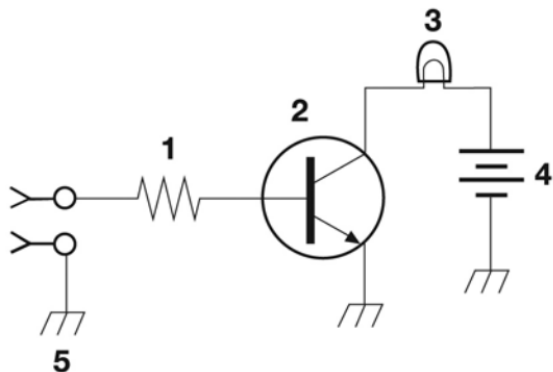

Figure T-1

- A. Resistor
 - B. Transistor
 - C. Battery
 - D. Ground symbol
3. What is the customary minimum frequency separation between SSB signals under normal conditions?
 - A. Between 150 and 500 Hz
 - B. Approximately 3 kHz
 - C. Approximately 6 kHz
 - D. Approximately 10 kHz
 4. What type of satellite appears to stay in one position in the sky?
 - A. HEO
 - B. Geostationary
 - C. Geomagnetic
 - D. LEO

Advanced Technical Information Online

By Bob, NW3M

The topic for this month's column is pretty down to Earth. In fact, it's all about getting "down to Earth."

Have you ever experienced that tingling sensation when your lips accidentally touch your microphone while transmitting? I know we all get a rush of excitement when making contact with a rare DX station, but trust me, that's not what's giving you that little tingling sensation.

Maybe that old clock radio you're only using as a station clock starts making noises whenever you talk on your radio, even though it isn't turned on. I've even had a set of computer speakers that were turned off and disconnected start making noise when I talked on the radio.

We've probably all heard a station talking that sounds like there's a scraping sound mixed in with their voice on the loud peaks. That is usually followed by some experienced ham advising the operator that it sounds like he/she has "RF in the shack."

These are all symptoms of a grounding problem with your station equipment. It really gets frustrating when you know you've installed a ground wire, or ground strap, from each piece of equipment to a ground rod right outside the window. Checking it with an ohm meter indicates that all the ground connections are tight and working with no measurable resistance in the system.

This is a perfect example of the big difference between DC resistance of a piece of wire, and the AC impedance of the same piece of wire. To DC, which the ohm meter uses to measure the resistance of the wire, it measures zero ohms resistance. But if you apply RF through an impedance bridge you will quickly see that the AC impedance of that wire changes with the frequency you are measuring it with.

While you might have a perfect ground system for DC, you may discover that for 20 meter radio frequencies your ground system has several hundred to a few thousand ohms of impedance, rendering it about as effective as a piece of nylon rope for grounding the equipment.

The article in the link below goes into an understandable explanation of the how and why you end up with RF in the shack despite your equipment being thoroughly grounded. It provides methods to diagnose your system and identify the weak spots and offers a few different ways to solve the problem.

Even if you haven't experienced any of these symptoms, it wouldn't hurt to read the article and look at your station grounding. Perhaps you'll find a better way to ground your station than you are currently doing.

<http://www.radioworks.com/nbgnd.html>

Hamfest & Conventions

09/25/2021 - Hollywood Maryland 7th Annual TailgateFest
Hollywood, MD St. Mary's County ARA <http://k3hki.org>

10/03/2021 CARA Fest 2021 West Friendship, MD Columbia Amateur Radio
Association (CARA) <http://www.carafest.org>

RV Radio Network Virtual



Extravaganza
&
ARRL Convention



Free with Registration required

Friday September 24, 1800, to ~2100 CDT
Saturday September 25 0900-1430 CDT

Speakers

Tom Abernethy W3TOM ARRL

Dwight Bonifield W8TJT Forum HF and camp setup

Mike Dorosin N6RDF Raspberry Pi Allstar Node

Greg Lapin N9GL RF exposure & RVers

Hank K4HM & Selene KG4RMT Montgomery Fulltiming/ Workamping

Mike Sokol Electrical pedestal safety

David Ventura KE0NA Digital modes DMR

It is **free**, you do not have to be a member (but gets an extra entry in grand prize drawing) but you do need to **register** <https://us02web.zoom.us/meeting/register/tZAlf-2hpzMrH9ZW5i6ehpY1GTBBQqv0hULP>

Prizes are gift certificates & tee shirts that will be mailed to you after the event but you must be present on Zoom drawing to win.

RV Radio Network information at <https://rvradionetwork.com/>

Questions? Contact host Michelle N3YRZ msack@verizon.net (301)932-8133

CCARC Activities

By Jeff – KB3SPH

3 September 2021 – Exam Session at **5:00 PM**, Monthly CCARC Meeting at **7:00 PM**.
Location: Marbury Baptist Church Hall, 4670 Bicknell Road, Marbury, MD 20658.

Agenda:

*Officer Reports

*Presentation: “RF Power Meter Project” by Bill – W8BL

Zoom:

We also plan to have the meeting available via Zoom:

Meeting ID: 820 1883 6081 Passcode: 586774

Join the 3 September CCARC Meeting via desktop/laptop/smartphone: <https://us02web.zoom.us/j/82018836081?pwd=dldMdThOWjZ3ajVQMnFIQ21QMi9oZz09>

Dial in via landline/cell phone and follow voice prompts:

301-715-8592

19 September 2021 – 6th Annual Connector Workshop/Antenna Build - 1:00 PM – 5:00 PM – For details visit: <https://thewebniche.net/>

1 October 2021 – Monthly CCARC Meeting at 7:00 PM – Presentation: “Arduino MURS Alert Project” by Jeff – KB3SPH. Other details TBD.

5 November 2021 – Exam Session at 5:00 PM, Monthly CCARC Meeting at 7:00 PM. Details TBD.

2021 CONNECTOR WORKSHOP

Mark your calendars for the **6th Annual Connector Workshop** (Red- Righting, Tongue-Upping the World since 2016) to be held at the QTH of Jeff – KB3SPH and Pam – KB3SWS in Indian Head on **Sunday, 9/19/2021**. This year's theme is "**Solar Sunday.**" We are also adding a **2- Meter Quad Antenna build project (see attached flyer)** to the workshop!

Who: Any interested person. This email is being sent to local area amateur radio operators. **Please feel free to forward this email to any individual/group that may have an interest.**

What: Free Connector Workshop focusing on learning about and constructing power cable assemblies using Anderson PowerPole connectors. Planned speakers include Charles – AA3WS and Jeff – KB3SPH.

Also: "Solar Sunday" Presentations on Various Solar Power Systems:

Kato – KB3LIB: Home/Cottage Solar Project

Steven – KC3DSO: Camping/Hiking/Vehicle Solar Systems

Jeff – KB3SPH: Field Deployable/Portable Solar System

When: Sunday, 19 September 2021 from 1300 – 1700 (1:00 PM – 5:00 PM).

Where:

Home of KB3SPH/KB3SWS, directions to be provided at a later date.

How (To):

- Briefs on how to use Anderson PowerPole connectors (the ARES/RACES standard) and demonstrations on various configurations to assemble
- Hands on use of PowerPole crimpers and insulated connector crimpers to assemble cables

(Continued on page 8)

(Continued from page 7)

- Hands on use of other crimp-on connectors, PL-259 connector installation, etc.
- Briefs and demonstrations on preparation of cables and soldering various connectors and Crimp-the-Shield/Solder-the-Pin connectors
- Hands on use of soldering equipment

Note: No experience or bringing of equipment is necessary, come and learn from others! If you have a situation where you need assistance in getting a connector/advice on equipment, please bring that equipment to the workshop and let the “Brain Trust” have a crack at solving the issue.

Why: Get the creative juices flowing!

If you are interested in attending the workshop, please let me know via return email (humbert1js@gmail.com) and include the number of people you're bringing with you.

73

Jeff - KB3SPH humbert1js@gmail.com Cell/Text: 301-848-8043



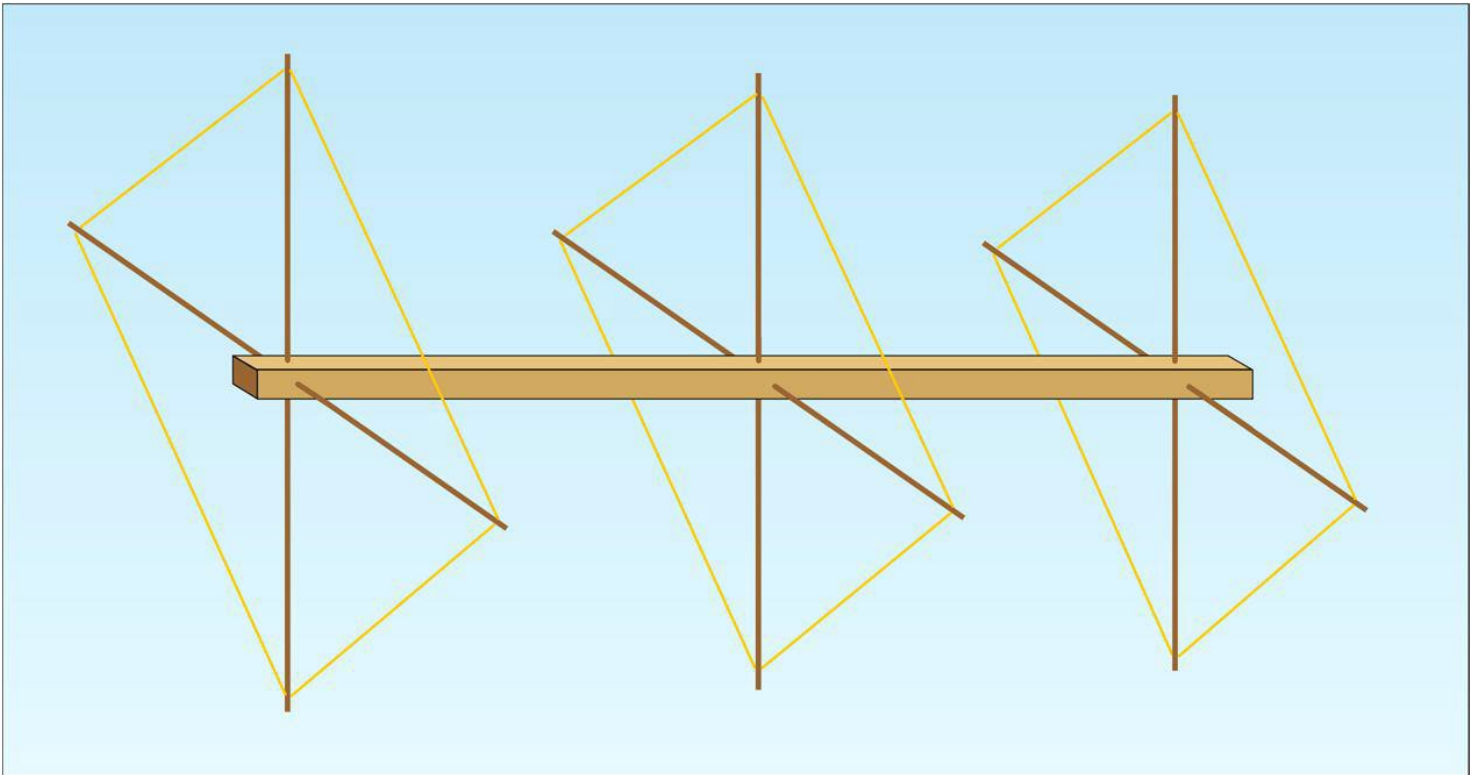

Last year, as a club project, the CCARC built a simple 3-element, 2-meter Yagi antenna based on the WA5VJB Cheap Yagi. This year we are going to build a 3-element, 2-meter Quad antenna.

The antennas will be constructed at the 6th Annual Connector Workshop on 19 September 2021 and led by Bob – NW3M. Assembly will involve gluing the element spreaders into the boom, threading the wires through the spreaders, attaching the coax cable, and testing the antenna.

The antenna kit will come with boom and spreader parts, wire, and coaxial cable with PL-259 connector. If your radio needs something different, please bring an appropriate adapter for testing. Glue for the project will be provided. The cost of the antenna kit will be \$20 and will be collected at the workshop.

To determine how much wire, coax, and materials we need to purchase, please submit your kit order via return email to humbert1js@gmail.com before end of meeting September 3 2021.

You do not need to be a member of CCARC to order a kit and participate



ARES Corner

Winlink Express and Email Part I

The Winlink system has its own email client called 'Winlink Express.' It is a free download from the Winlink site. To get to the download area, head over to www.winlink.org:



Once there, click on the "User Programs" link (circled above) and you'll be taken to the next page which gives a run-down comparison between different email clients for ARES use:

Compare Client Programs

Continued from page 6

Programs (Download)-> Features below	Outpost	AirMail	WoAD	Pat	Paclink- Unix	Paclink	Winlink Express
TELNET	Yes	Yes	Yes	Yes	Yes	Yes	Yes
AX.25 PACKET	Yes	Yes	Yes	Yes	Yes	Yes	Yes
FACTOR 1-3	No	Yes	No	Yes	Yes	Yes	Yes
FACTOR 4	No	Yes	No	Yes	No	Yes	Yes
ARDOP	No	No	Yes	Yes	No	No	Yes
VARA HF and VARA FM	No	No	No	No	No	No	Yes. VARA is speed-limited unless licensed.
Password- protected Secure Login	Yes	Yes	Yes	Yes	Yes	Yes	Yes
Supports B2F protocol & mail attachments	No	Yes	Yes	Yes	Yes	Yes	Yes
Sound card	Yes with AGWPE	Yes with AMPE or AGWPE	Yes	Yes	Yes	Yes	Yes
Most any TNC (Packet)	Yes	Limited Yes with AMPE and AGWPE	Yes	Yes KISS (Linux only) Most w/transparent mode	Yes	Yes KISS and AGWPE	Yes KISS

At the bottom of the page is a link to the download section. It will take you an initial download page showing two options:

downloads.winlink.org - /

```
7/14/2021  2:39 PM      <dir> Sysop Programs
7/18/2021 11:41 AM      <dir> User Programs
```

Click on the 'User Programs' link and you'll be taken to the next page that shows you the various user programs that can be downloaded:

downloads.winlink.org - /User Programs/

[\[To Parent Directory\]](#)

5/21/2018	6:55 PM	626	Latest VARA Modem download site.rtf
7/19/2018	6:23 AM	1846835	Paclink_install_4-3-11-0.zip
5/21/2018	6:55 PM	1132	README_Software_Install_Instructions.txt
11/20/2020	9:22 AM	847697	RMS_Link_Test_install_2-0-24-0.zip
5/21/2018	6:55 PM	12176	SCS_PTC-IIIusb_and_end_of_PTC-IIusb_IIpro_IIex.pdf
7/18/2021	11:42 AM	22282156	Winlink_Express_install_1-5-39-0.zip

Click on the "Winlink_Express_Install_####.zip" to download the most recent version of the software. The downloaded file is in .zip format. Most windows PCs understand .zip files and will give you an option to extract the file:

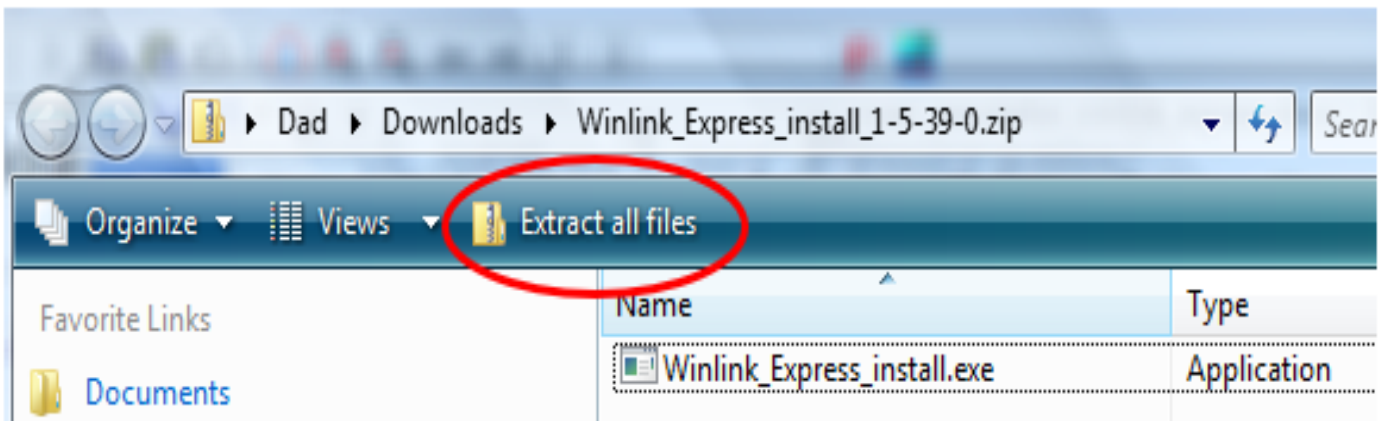

The system will then prompt you for a location to save the file. Pick a location that is easy to remember. When you go to that location, you'll find the file. It is recommended that you right click on the file and from the pop-up menu, run the installation as an Administrator:

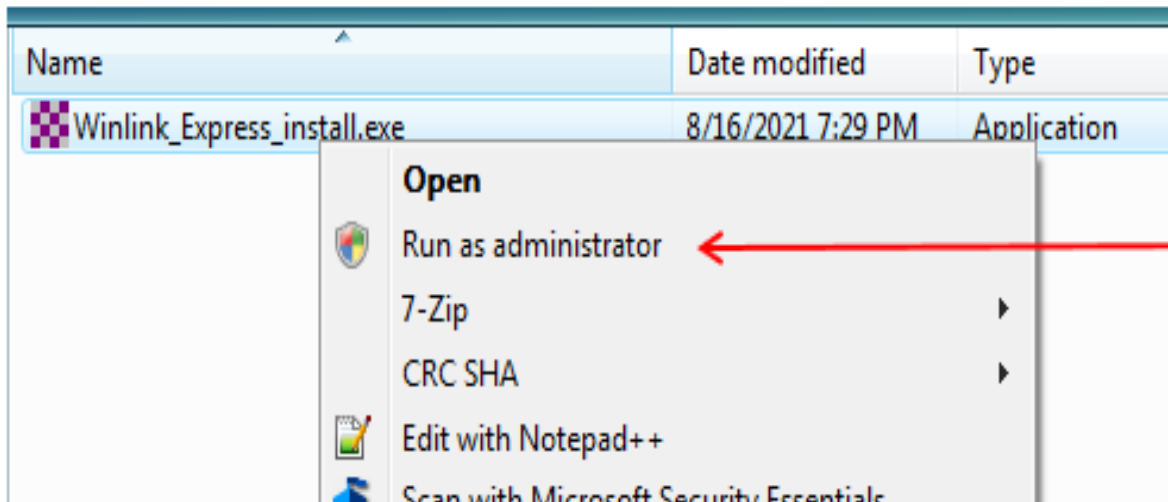

Windows will normally walk you through various questions as you install the software. It does provide a default location for installation:

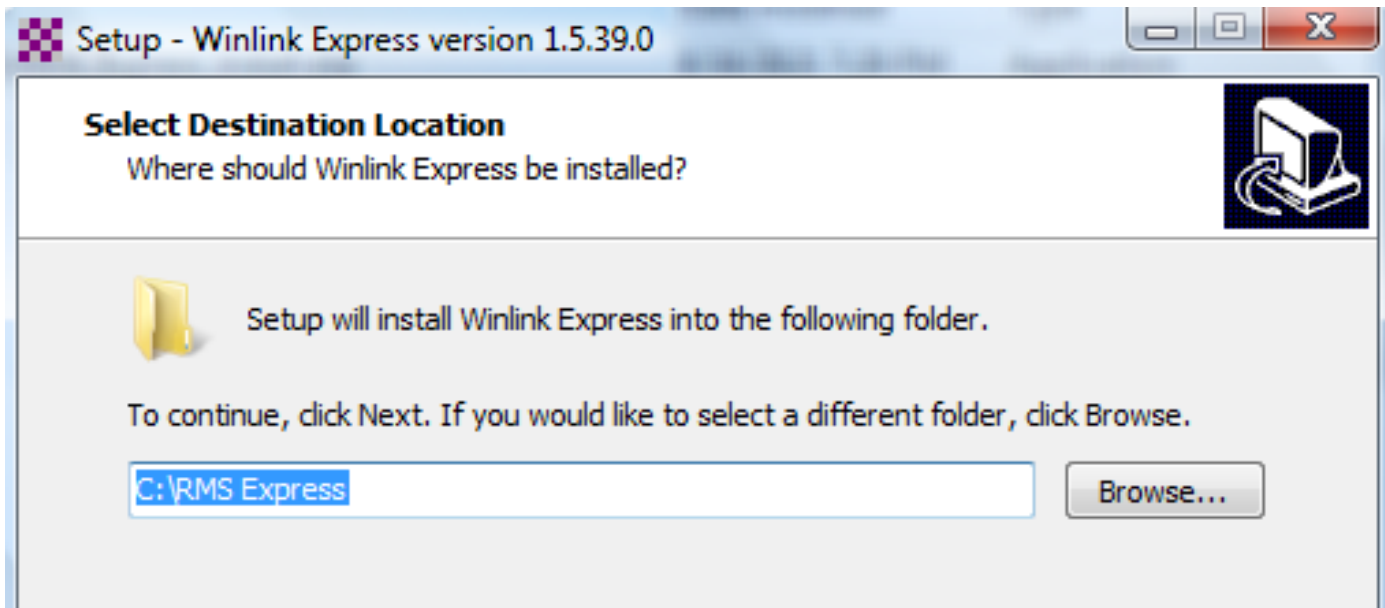

Once the install process is completed, you have the option to start Winlink Express. If this is your first time, you'll be greeted with a configuration screen:

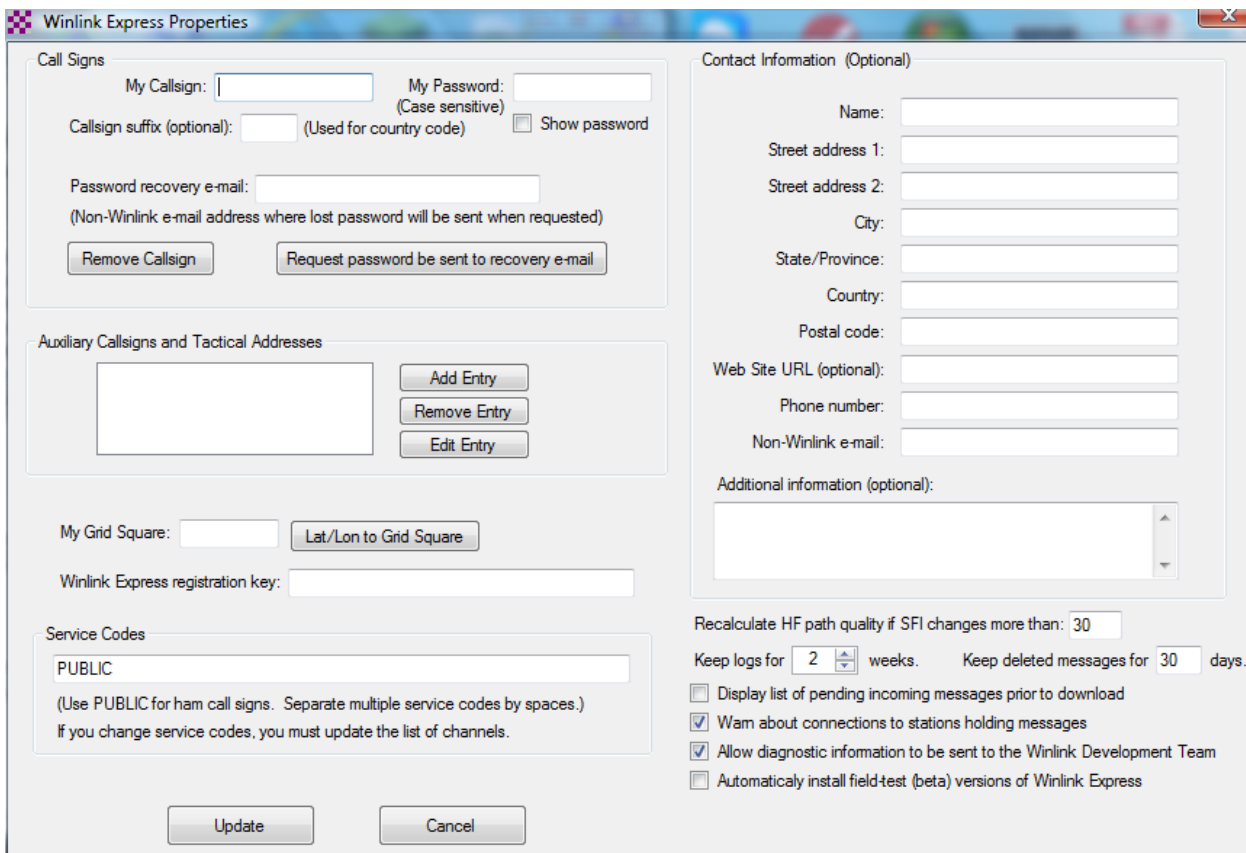

You're on your way to getting your Winlink account established and we'll pick up next month with getting your account established and making your initial

There are many National Days to celebrate

Charles County has a site that will offer you emails (or texts if you prefer) full of EVENTURES to fill your calendar.

Here are some from their latest email:

- 9/4 - Shake The Room Live Music Debut
- 9/4 – 9/8 - Southern Maryland Sunflower Festival
- 9/16 – 9/19 - 97th Annual Charles County Fair
- 9/15 – 10/15 - Hispanic Heritage Month
- 9/25 - St. Charles Running Festival
- 9/26 - Charles County Lobster Festival
- 9/27-Foodie festival
- Throughout September, *12 Angry Jurors* showing at Port Tobacco Players
- Blue Crabs Baseball season is still in full swing

Check it out and sign up at www.ExploreCharlesCounty.com

You can also find a Fall Parks and recreation guide for Charles County at <https://www.charlescountyparks.com/recreation/the-guide>

CCARC weekly net

Charles County Amateur Radio Club net each Wednesday 2030 local time
147.195 MHz, + 600 offset, PL 156.7 Hz. If repeater fails 146.480 simplex

EchoLink KB3KOW-R (when available, watch emails)

Follow us on Netlogger

Nets will be roundtable type with a question of the week for discussion. All amateur radio operators are welcome; please join in the fun!

Sign up for net control at

<https://www.signupgenius.com/go/20F0B48ACAB2CA5F85-ccarc>

VHF-UHF FT8 Activity Contest	1, 8	SKCC Weekend Sprintathon	11 to 12
CWops Mini-CWT Test	1-3, 8-9, 15-16, 22-23, 29-30	Alabama QSO Party	11 to 12
UKEICC 80m Contest	1, 29	Russian Cup Digital Contest	11 to 12
Phone Weekly Test - Fray	1	ARRL September VHF Contest	11 to 13
G3ZQS Memorial Straight Key Contest	1 to 3	North American Sprint, CW	12
NRAU 10m Activity Contest	2	4 States QRP Group Second Sunday Sprint	13
SKCC Sprint Europe	2	RSGB 80m Autumn Series, CW	15
Walk for the Bacon QRP Contest	2 to 3, 16	NAQCC CW Sprint	16
RTTYOPS Weeksprint	2, 7, 9, 14, 16, 21, 23, 28, 30	BCC QSO Party	16
EACW Meeting	2, 9 16, 23, 30	AGB NEMIGA Contest	17
K1USN Slow Speed Test	3, 6, 10, 13, 17, 20, 24, 27	NCCC Sprint	17, 24
NCCC Sprint Ladder	3, 10	QRP Afield	18
NCCC RTTY Sprint	3, 10, 17, 24	Wisconsin Parks on the Air	18
CWops CW Open	4	Feld Hell Sprint	18
Russian RTTY WW Contest	4	SARL VHF/UHF Digital Contest	18 to 19
Wake-Up! QRP Sprint	4	ARRL 10 GHz and Up Contest	18 to 19
AGCW Straight Key Party	4	Scandinavian Activity Contest, CW	18 to 19
Two-Meter Classic Sprint	4	Iowa QSO Party	18 to 19
Portable Operations Challenge	4 to 5	Texas QSO Party	18 to 19
IARU Region 1 Field Day, SSB	4 to 5	Washington State Salmon Run	18 to 19
RSGB SSB Field Day	4 to 5	New Jersey QSO Party	18 to 19
Colorado QSO Party	4 to 5	New Hampshire QSO Party	18 to 19
All Asian DX Contest, Phone	4 to 5	North American Sprint, RTTY	19
IARU Region 1 145 MHz Contest	4 to 5	BARTG Sprint PSK63 Contest	19
PODXS 070 Club Jay Hudak Memorial 80m Sprint	4 to 5	Collegiate QSO Party	19 to 20
WAB 144 MHz QRO Phone	5	Run for the Bacon QRP Contest	19 to 20
Tennessee QSO Party	5 to 6	144 MHz Fall Sprint	20
RSGB 80m Autumn Series, SSB	6	SKCC Sprint	22
MI QRP Labor Day CW Sprint	6 to 7	RSGB 80m Autumn Series, Data	23
ARS Spartan Sprint	7	Masonic Lodges on the Air	25
Worldwide Sideband Activity Contest	7, 14, 21, 28	AGCW VHF/UHF Contest	25
Phone Weekly Test - Fray	8, 15, 22, 29	CQ Worldwide DX Contest, RTTY	25 to 26
FOC QSO Party	11	Maine QSO Party	25 to 26
Ohio State Parks on the Air	11	UBA ON Contest, 6m	26
WAE DX Contest, SSB	11 to 12	QCX Challenge	27 to 28
SARL Field Day Contest	11 to 12	RSGB FT4 Contest Series	27
YB7-DX Contest	11 to 12	222 MHz Fall Sprint	28

Contests in September

Back to school

V T L S Q K G R W M A M U G I
L C E O Z S X F M P C O I B X
Z P Y L O V S B D O B O V Q I
W J E X Y H U E M O Y R M L M
O R Y N Z N C P C Y W H H O P
J T L Q S T U S R E X C Y O V
Y L G F H T E A H W R N S H V
S T U D E N T A B G Q U P C B
K H F R K N X U C O I L N S V
E L O S E Y S Z Y H T H B E I
R E B M E T P E S D E E O L D
X P E N C I L S K I L R O D E
H L L A P I C N I R P Z K D O
E O Z J U W Q O K W V U S I S
T O X B D O X H Q J T X O M D

Computer
Lunchroom
Pens
September
Videos

Books

Bus

Elementary

HighSchool

MiddleSchool

Pencils

Principal

Recess

Student

Teacher

Thanks to Martin Blaise AG5T for the new puzzle for the newsletter.

September 11 or Nine Eleven or 9/11 or Patriot Day



It is one of the days we'll never forget. Some people refer to it as a day of infamy and like Pearl Harbor's bombing, you can ask anyone they will tell you where they were when they heard. Except now we note that 20 years have passed, so some adults do not have personal memories of the events. Some special commemorations are planned on this the 20th year since the attacks & I am listing a few at the end of this article.

The loss of life on September 11, 2001, began when terrorists hijacked American Airlines flight 11 enroute to Los Angeles after takeoff from Boston with 11 crew and 76 passengers. The 5 terrorists flew the plane into the floors 93-99 of the north tower of the World Trade Center in New York City at 8:46 am.

Seventeen minutes later, (9:03) United Airlines flight 175 (hijacked enroute to Los Angeles from Boston) with 9 crew and 51 passengers impacted with floors 77-85 of the south tower of the World Trade Center in New York City.

Terrorists hijacked American Airlines flight 77 after takeoff from Dulles Airport in Washington, DC heading for Los Angeles and flew 6 crew and 53 passengers into the west side of the Pentagon at 9:37AM. All onboard and 125 in the Pentagon were killed.

At 9:42 a.m., the Federal Aviation Administration (FAA) grounded all civilian aircraft. Another 767 heading to Los Angeles from Boston, Delta Flight 1989 became suspect that it might also be hijacked, however it obeyed the directions and landed safely in Cleveland, Ohio.

The last plane United Airlines flight 93, hijacked enroute from Newark to San Francisco with 7 crew and 33 passengers; was prevented from hitting a target in DC by the passengers and crew. They had learned of the other events so with a "let's roll" call from Todd Beamer overpowered the terrorists and the plane crashed into a field near Shanksville, Pennsylvania at 10:03AM. All onboard were killed.

(Continued on page 19)

At 9:59 the south tower of the World Trade Center collapsed, followed by the north tower at 10:28. Loss of life at the WTC included all aboard both flights, 2606 in the buildings.

Initial total deaths were 2996 with over 6000 injuries. Health issues from the dust and smoke clouds have caused more deaths and disabilities in the years following the collapse of the buildings. There were also 11 pregnancies lost and a 74-77% increase in premature births (boys more than girls) attributed to 9/11 in New York.

Post-Traumatic Stress Disorder affected many; some had immediate distress while others took years. This caused the numbers to vary from 20%-97% in emergency workers involved to 2%-30% of the general population.

However, despite that this was the highest death toll from a terrorist event on the US land, it could have been even more as the tower averaged about seventy thousand workers and tourists each day. Estimates range between 16000 and 18000 were in the buildings when the planes hit, and the majority got out alive. Many of those who worked in office assisted others out; 18 survived from above impact floors. EMS, fire, and police rescued some though many of those emergency workers perished with the collapse of the structures. Other buildings in the complex also collapsed but were empty at the time. Thousands volunteered at the site dubbed "Ground Zero" to rescue, recover bodies, and clean. The last fire at the site was put out on December 20. The last piece of the WTC was removed on May 30, 2002.

Identification of remains is still on-going using DNA profiling. Searches in 2006 (Deutsche bank site) and in 2010 at the landfill brought more remains to identify. Newer technology helped bring total identified remains to 1845. There are still about ten thousand bone/tissue fragments and 1108 victims not yet identified.

Damages were not confined to the towers. Some of the train system, like the one under the WTC, were demolished. Tunnels flooded. In addition to all the buildings in the World Trade Center, other nearby buildings sustained damage. With over \$10billion in damages, the economy, especially in New York, took a hard hit. Wall Street was closed through the 17th. In addition to air travel, many other companies were closed, and events cancelled. Some companies housed in the WTC lost entire staff and holdings. Many no longer had jobs. Emergency services were compromised by the large loss of personnel at the WTC.

One section of the Pentagon collapsed; light poles and a generator were broken by the plane. Fires, smoke, and debris from the tail sections penetrated furthest into the building.

War against terrorists began. Deaths from the war are about 442300 (10008 are US military). May 2, 2011, Osama ben Laden, the leader of the Al Qaeda group who perpetrated the attacks, was killed. Lawrence Wright theorizes that September 11 was chosen because the date signified the start of the battle for Vienna in 1683; a defeat allowed the West dominance because Islam was forced to retreat by the King of Poland. The date would allow muslims to now win back that dominance and instill terror.

Ham radio

When the World Trade towers (with equipment and antennas on the top) collapsed, a lot of telecommunications were lost in New York City. RACES was activated and amateur radio operators stepped up to establish alternate communication. Check out the great article about the response in the QST November 2001 issue and note the 10-year-old ham who manned a shelter communications post by herself – for 8hours!

The Pentagon attack problem with communication wasn't due to loss of equipment but to overload of the system. Hundreds volunteered and helped, including some from our club. I'd love to acknowledge all those members who helped...if you let me know I'll post the list in the next Smoke Signals.

Amateur response was not confined to the locations of the attacks, many areas around the US experienced overloaded phone lines. Many ARES, RACES and other amateur operators activated to assist.

20th Anniversary Commemorations

New York- Access to the National September 11 Memorial & Museum will begin at 7:00 a.m. A ceremony exclusively for 9/11 family members starts at 0830. Family members of 9/11 victims will gather on the Memorial Plaza to read aloud the names of those killed in the 9/11 attacks. It will include six moments of silence acknowledging when each tower was struck/fell, the Pentagon was struck, and Flight 93 crashed. "Houses of worship to toll their bells at that time." ("20th Anniversary Commemoration | National September 11 ...") At sundown, the annual "Tribute in Light" will once again illuminate the sky in



commemoration of the anniversary of the attacks. [in Light](#) 9/11/14, view in [Bayonne, New Jersey](#)

[Tribute](#)

(Continued from page 20)

Flight 93 memorial in PA: Free and open; public is encouraged to attend events:

Thursday, September 9, 2021 5:00 pm 'Witness to History' series "A Monumental Task": The Military & Civilian Air Response September 11, Visitor Center Complex

Friday, September 10, 2021 3:00 pm "A Field of Honor Forever": Creating the Flight 93 National Memorial Visitor Center Complex
Luminaria, evening 40 candle lanterns lit and carried by family members and placed below the names of each on Flight 93 The Johnstown Symphony will participate as the musical accompaniment for the Luminaria Ceremony. Memorial Plaza: Wall of Names

Saturday, September 11, 2021, 9:45 annual observance Memorial Plaza. At 10:03 a.m. – the moment Flight 93 crashed – the names of the passengers and crew members will be read, the Bells of Remembrance will be rung in their memory, and a wreath will be placed at the Wall of Names. At the conclusion of the wreath laying, the ceremonial gate to the crash site will be opened and family members will walk out to the crash site. Johnstown Symphony Orchestra will perform Dvořák's *Symphony No. 9 "From the New World,"* in a community concert as part of the memorial observance

Sunday, September 12, 2021, 10:00 am "Large Plane Down!": First Responders to Flight 93 Visitor Center Complex

12:30 "A Crime Scene": The Flight 93 Crash Investigation Visitor Center Complex

Tunnel to Tower Walk. A group walks from the Pentagon to ground zero via the flight 93 site in Pennsylvania. They also host a mobile museum.

Special event K4A commemorating 20th Anniversary of 9-11
September 5th 0000 UTC to 12th 2359 SSB / CW and DIGITAL MODES
QSL with SASE to WA1FCN ROBERT F BEAUDOIN 970 Mt View Rd Cordova, AL 35550



("ALABAMA CONTEST GROUP | K4ACG")



(Continued on page 22)

Plan Your Own Observance

Suggestions from the 9/11 Memorial Museum & the Flight 93 Memorial sites

New York 9/11 Memorial Museum 180 Greenwich Street in lower Manhattan <https://www.911memorial.org/> (will also provide stuff to help commemorate like media or archival and current photographs). World Trade Center or Ground Zero cross



steel beams found among the debris.

James Tourtellotte, U.S. Customs

9/11 Pentagon Memorial closed due to Covid Park with 184 benches facing the spot Flight 77 crashed into the building. <https://pentagonmemorial.org/plan/visitor-resources>

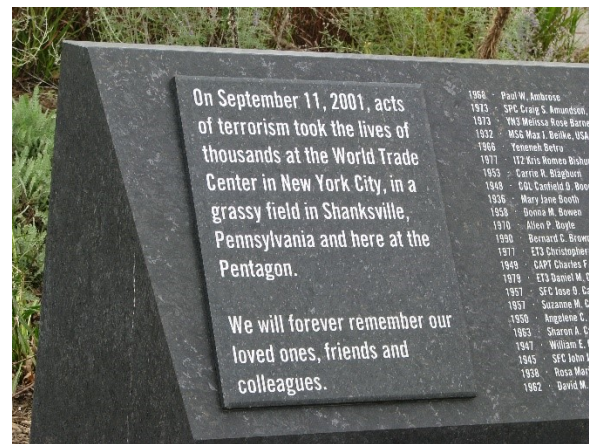

Michelle Sack

Flight 93 Memorial near Shanksville, a white marble Wall of Names and a visitor center beneath the path of Flight 93. **6424 Lincoln Highway, Stoystown, PA 15563** <https://www.nps.gov/flni/index.htm>



Michelle Sack

Only one piece of art survived- The Sphere by Fritz Koenig. You can see it in its original place by the 911 memorial. https://en.wikipedia.org/wiki/The_Sphere

New York City firefighters donated a cross of steel from the towers and placed it on top of a platform shaped like the Pentagon outside the firehouse in Shanksville

Silence or ring bells: observe the times of the tragic events Times are in Eastern US zone

- **08:46** first plane hit north tower
- **09:03** plane hit the other tower
- **09:37** Pentagon was hit
- **09:59** south tower fell
- **10:03** plane crashed into field
- **10:28** the collapse of north tower

Acknowledge the victims by reading aloud You can obtain a guide from the 9 11 museum site that allows you to read all the names, the ones from an area, or by other criteria.

Fly your flag at half-mast from 8:46 a.m. (first plane struck) until sunset on Patriot Day

Check the web and learn more about the horror, heroism, sacrifices, see historic photos, & video reports. Some sites are:

102 Minutes That Changed America <https://watch.historyvault.com/specials/102-minutes-that-changed-america?cmpid=editorial>

Voices of September 11th <https://voicescenter.org/>

Digital [Archive https://911digitalarchive.org/](https://911digitalarchive.org/)

<https://pentagonmemorial.org/learn/911-pentagon>

<https://www.911memorial.org/911-faqs>

<https://www.nps.gov/flni/planyourvisit/september-11-events-schedule.htm>

<https://www.911memorial.org/plan-your-own-911-anniversary-observance>

<https://neverforget.org/remember/>

<https://www.911memorial.org/connect/commemoration/20th-anniversary-commemoration>

https://en.wikipedia.org/wiki/September_11_attacks

<https://www.history.com/topics/21st-century/9-11-attacks>

<http://www.arrrl.org/files/file/WTC.pdf>

<https://t2t.org/20-anniversary/>



<https://www.gettysburgflag.com/flags-banners/remember-911-flag>

Special events in September

08/27/2021 | Amateur Radio Software Awards

Aug 27-Sep 5, 0500Z-0459Z, K2A/K2R/K2S, Ames, IA. Amateur Radio Software Award. 14.250 7.185 3.950 7.078. QSL. Amateur Radio Software Awards, Special Event Station, PO Box 126, Ames, IA 50010-0126. Special event stations K2A, K2R, and K2S are operating from Iowa, Colorado and Washington to promote free and open amateur radio software. During the event the 2021 Amateur Radio Software Award recipient Jordan Sherer will be honored for his JS8Call digital communication software. Nominations for the 2022 awards will also be encouraged. Please QSL with S.A.S.E. The Amateur Radio Software Award is an annual international award for the recognition of software projects that enhance amateur radio. The award aims to promote amateur radio software development which adhere to the same spirit as amateur radio itself: innovative, free and open. For more information about the Amateur Radio Software Award or a detailed schedule of the special visit arsaward.com

08/28/2021 | 65th Annual Auburn, Cord, Duesenberg Festival

Aug 28-Sep 8, 0000Z-2359Z, K9A, Auburn, IN. Northeastern Indiana Amateur Radio Association (W9OU). 14.074 7.225 7.074 7.030. Certificate & QSL. K9A C/O Northeastern Indiana ARA, P.O. Box 145, Auburn, IN 46706. www.w9ou.org

08/28/2021 | Buhl Day Celebration

Aug 28-Sep 7, 0800Z-2200Z, W3B, Sharon, PA. Mercer County Amateur Radio Club. 7.185 14.240 145.350. QSL. Mercer County Amateur Radio Club, PO Box 996, Sharon, PA 16146. W3B Special Event Station The Mercer County Amateur Radio Club is celebrating BUHL DAY, the 106th anniversary of Buhl Farm Park, which covers 300 acres in the Shenango Valley. The Park was given to the Shenango Valley community by Frank Buhl, a local industrialist, for the use and recreation enjoyment of the community in Mercer County, PA. A commemorative QSL will be available with a SASE. Send your QSL card to: Mercer County Amateur Radio Club PO Box 996 Sharon, PA 16146 USA www.w3lif.org

09/01/2021 | 130 Year Anniversary of the First K.U.K. Telegraphy Course

Sep 1-Oct 30, 0000Z-2359Z, OE130KUK, Kirchberg am Wagram, AUSTRIA EUROPE. ADL 305 Tulln-Stockerau. 160 through 10 meters, CW SSB FT8. QSL. See website, for, information, AUSTRIA EUROPE. In 1891 a k.u.k cavalry telegraphist course was first established in the "Franz Josef-Casern" in Tulln (Lower Austria). In the following years (up to approx. 1917) infantry companies were also stationed in Tulln to learn telegraphy. That was unique in the imperial-royal monarchy Austria-Hungary. k.u.k stands for kaiserliche und königliche Monarchie Österreich-Ungarn. "k.u.k." was the unofficial abbreviation for the Austro-Hungarian Monarchy. www.qrz.com/db/oe130kuk

09/03/2021 | W4V - HOOAH Deer Hunt for Heroes

Sep 3-Sep 6, 2300Z-2300Z, W4V, Normal, IL. Chicago Suburban Radio Association - W9SW. 14.320 7.260. QSL. Ron Delpiere-Smith -- W4V, 333 E Vermont St, Villa Park, IL 60181-2267. Members of the Chicago Suburban Radio Association will be activating W4V – HOOAH Deer Hunt for Heroes Special Event Station over the 2021 Labor Day Weekend. Through sponsorship, donations and fundraising activities the HOOAH Organization arranges Hunting and Fishing activities for Disabled Veterans. This allows the veteran to participate without any cost to the themselves. The purpose of W4V Special Event is to bring awareness to the opportunities available to our disabled veterans through the HOOAH organization. The W4V activation will be from 2300 UTC September 3, 2021 to 2300 UTC September 5, 2021 (possible on September 6) on 20, 40 & 80 meters More information about HOOAH can be found at: www.HooahDeerHuntforHeroes.com. www.w9sw.com

09/04/2021 | Fly-IN / Cruise-IN

Sep 4, 1200Z-1900Z, W9EBN, Marion, IN. Grant County Amateur Radio Club. 14.1800 DMR Talk Group 31189 D-Star Ref 24B 146.790- (PL 141.3). Certificate. Grant County Amateur Radio Club - W9EBN, ATTN: Fly-In / Cruise-In, P.O. Box 1786, Marion, IN 46952. Send a 9 inch x 12 inch Self Addressed Stamped Envelope (SASE) to receive a certificate. www.grantarc.org

(Continued on page 25)

09/04/2021 | Return to Paradise

Sep 4-Sep 6, 1800Z-1800Z, K7RDG, Sierra Vista, AZ. Cochise Amateur Radio Association. 14.285 7.225 3.890 14.070. Certificate. Cochise ARA, PO Box 1855, Sierra Vista, AZ 85636. Operating Voice, FT8/FT4/JS8Call from the Ghost Town of Paradise,AZ. WWW.K7RDG.ORG

09/04/2021 | Sanders County Fair

Sep 4-Sep 5, 1600Z-2200Z, W7P, Plains, MT. Clark Fork Amateur Radio Club . DMR TG 31300 Brandmeister Network; 50.313 50.323 7.074. QSL. Clark Fork Valley Amateur Radio Club, P.O. Box 1803, Thompson Falls, MT 59873. cfvarc.org

09/05/2021 | 20th Memorial of the 9/11 Attacks

Sep 5-Sep 12, 0000Z-2359Z, K4A, Cordova, AL. Alabama Contest Group. 3.850 7.250 14.250 21.325. QSL. Bob Beaudoin, 970 Mountain View Road, Cordova, AL 35550. CW freq 50 Khz up from the bottom of the band All frequencies +/- QRM Normal FT-8 frequencies www.alabamacontestgroup.org

09/05/2021 | Blue Ridge Bonanza

Sep 5, 1300Z-2100Z, W4CA, Roanoke, VA. Roanoke Valley Amateur Radio Club. 14.265 7.265. QSL. Roanoke Valley ARC, P.O. Box 2002, Roanoke, VA 24009. Multiple stations/frequencies on 20 and 40 meters. Contact as many stations along the Blue Ridge Parkway during the event. Commemorating the beginning of construction of the Parkway in September, 1935. A 469 mile scenic road running along the spine of the Blue Ridge Mountains through Virginia and North Carolina. <https://blueridgebonanza.info>

09/06/2021 | Tommy Thevenow Day

Sep 6, 1700Z-2259Z, W9EFU, Madison, IN. Clifty Amateur Radio Society. 28.347 14.247 7.247. Certificate. Jerry Barnes, 601 Spring Street, Madison, IN 47250. Calling CQ TT. Electronic Certificate upon confirmed QSO. Contact Jerry KA9PIJ@arrl.org. Thomas Joseph Thevenow (September 6, 1903 – July 29, 1957) born in Madison Indiana, was an American professional baseball shortstop. He played in Major League Baseball (MLB) from 1924 to 1938 for the St. Louis Cardinals, Philadelphia Phillies, Pittsburgh Pirates, Cincinnati Reds, and Boston Bees. Thevenow epitomized the good-fielding / weak-hitting shortstops that prevailed in the era, ending his career with a fielding percentage of .947, but a batting average of .247 while hitting only two home runs in his 15-year career. He hit two home runs in 1926, both inside-the-park home runs, and then never hit another home run in his next 12 seasons, setting a major league record of 3,347 consecutive at bats without a home run. wjbarnes@cinergymetro.net or <https://w9efu.wordpress.com>

09/09/2021 | September 11th 20th Anniversary Never Forget

Sep 9-Sep 13, 1600Z-0200Z, N7F, Albany, OR. American Legion Post 10 Amateur Radio Club. 14.250; 20 & 40 meters SSB, PSK-31, CW. QSL. N7F Never Forget, c/o American Legion Post 10, 1215 Pacific Blvd. SE, Albany, OR 97321. QSL with SASE. Club members may operate from home. info@n7ala.org or <https://www.n7ala.org>

09/10/2021 | In remembrance of the 20th anniversary of attack on World Trade Center in New York City

Sep 10-Sep 13, 0000Z-0003Z, WA2NYC, Staten Island, NY. Wireless Association of New York City. 28.450 21.350 14.340 7.238. QSL. Wireless Association of New York City, 233 Wolverine Street, Staten Island, NY 10306. We remember the over twenty nine hundred souls that were lost on that day. D-STAR Reflector XLX020B will be monitored at the top of the hour wa2nyc@yahoo.com

09/11/2021 | Burnsville Fire Muster

Sep 11, 1600Z-2100Z, W0BU, Burnsville, MN. Twin Cities Repeater Club (TCRC). 3.850 7.225 14.250 21.325. Certificate. TCRC , 4202 153rd Street West, Rosemount, MN 55068. Celebrating the 40th anniversary of the event, which the TCRC has regularly participated in. Weather permitting, we will be operating on solar power! Information: info@tcrc.org. www.tcrc.org

09/11/2021 | Flight 93 20th Anniversary

Sep 11, 1200Z-2359Z, N3M, Stoystown, PA. Somerset County Amateur Radio Club and Nittany Amateur Radio Club. General portion of 20 and 40 meter phone bands. QSL. N3M c/o Nittany Amateur Radio Club, PO Box 614, State College, PA 16801. Operating from the Flight 93 National Memorial, commemorating the passengers and crew of Flight 93 whose heroic actions on 9/11/2001 prevented a planned terrorist attack on the US Capitol. www.qrz.com/db/n3m

09/11/2021 | National POW MIA Recognition Day

Sep 11-Sep 19, 0000Z-2359Z, K4MIA, Loxahatchee, FL. PBSEC. 28.400 18.150 14.265 7.195. QSL. Michael Bald, 6758 Hall Blvd, Loxahatchee, FL 33470. Observance of National POW MIA Recognition Day are held across this country on the third Friday in September each year. This year it will be on September 17. This will be the 13th year the special event station has been activated. The day was established to honor our prisoners of war and those who are still missing in action. There will be sister stations K4MIA/1, K4MIA/5 K4MIA/7 and K4MIA/8 in operation. Days listed above are primary operational days and modes will operate SSB, CW, FT8 and Satellite operation. Throughout the month of Sept., K4MIA will hopefully try EME, Microwave and other less used digital modes. See QRZ for additional information and a copy of this year's QSL card. Because of the volume of requests, you MUST SEND SASE to get a returned QSL. Please take time to remember our POW's and MIA's as well as their families. www.qrz.com/db/k4mia

09/11/2021 | Route 66 On The Air

Sep 11-Sep 19, 0001Z-2359Z, W6JBT, San Bernardino, CA. Citrus Belt Amateur Radio Club. 3.866 7.266 14.266 28.466. Certificate & QSL. Citrus Belt Amateur Radio Club, PO Box 3788, San Bernardino, CA 92413. Come join the fun celebrating the road that built America. Opened in 1926, US Route 66 was the first major improved highway to link the West Coast with the nation's heartland; it once served as the backdrop for a popular TV show and has been the subject of songs and stories. There will be 21 stations — two of them “rovers” — operating in or around the major cities along Route 66 from Santa Monica, California to Chicago, Illinois. They will use 1 × 1 W6-prefix special event call signs. www.w6jbt.org

09/11/2021 | USS Midway Museum Ship Special Event: USS Midway Commissioning

Sep 11, 1600Z-2300Z, NI6IW, San Diego, CA. USS Midway (CV-41) Museum Ship. 14.320 7.250 PSK and CW on various HF bands DSTAR on various reflectors. QSL. USS Midway Museum Ship COMEDTRA, 910 N Harbor Drive, San Diego, CA 92101. Please check spotting networks to find us on HF. Consult www.dstarusers.org to find our call sign NI6IW and Reporting Note to see what reflector we're using. Note: Typical QSL turn-around time is 4 to 6 weeks after receiving request with SASE. www.qrz.com/db/ni6iw

09/17/2021 | Clay County Pioneer Day

Sep 17-Sep 18, 1700Z-0459Z, KF5DFD, Henrietta, TX. Clay County Amateur Radio Club. 7.255 14.255 . QSL. Brent Boydston, 103 N. Crockett St., Henrietta, TX 76365. The inaugural gathering of old-time residents of Clay County was called for August 19, 1932, at 3 p.m. by a group of local club women. The Clay County Pioneer Association was organized at this meeting. Committees were appointed to formulate it's Constitution and By-Laws, and to arrange for its First Reunion October 28, 1932. Today it is a big homecoming for the entire area and a real live Rodeo. Hats are not optional! Check in to the event and learn more about the interesting history of Clay County Texas. Keep an eye on the Clay County Skywarn FB

page (www.facebook.com/groups/skywarn.clay.county) for more information about event. Bonus dates, times and hours may be added!. www.facebook.com/groups/skywarn.clay.county

09/17/2021 | WBZ AM 1030 100th Anniversary

Sep 17-Sep 19, 1300Z-2359Z, W1W/W1B/W1Z, Billerica, MA. Billerica Amateur Radio Society (B.A.R.S.) and Hampden County Radio Association (HCRA). 18.150 14.250 7.275 3.950. Certificate & QSL. Douglas A Bruce, 67 John Street, Reading, MA 01867-2701. <https://nediv.arrl.org/wbz100>

09/18/2021 | 75th Anniversary Moses Scout Reservation

Sep 18, 1300Z-1900Z, W1M, Russell, MA. Western Mass Council BSA. 14.250 7.250. QSL. Tom Barker, WA1HRH, 329 Faraway Road, Whitefield, NH 03598. special qsl via eqsl and sase via usps.

09/18/2021 | 80th Anniversary of the Launch of the USS Massachusetts

Sep 18, 1000Z-1600Z, NE1PL, Fall River, MA. USTNR. 14.258. QSL. Rick Emord, 135 Wareham st, Middleboro, MA 02346. We will be on 20 and 40 meters at least, spotted on the cluster, phone for sure, digital and cw are possible. contact kb1tee or n1umj for details/info/questions. www.ne1pl.org

09/18/2021 | Harvey House on the Air

Sep 18, 1400Z-2100Z, W0EBB, Leavenworth, KS. Pilot Knob Amateur Radio Club. 28.380 21.380 14.280 7.260. Certificate & QSL. Charles Jackson, 717 Mt. Calvary Rd, Lansing, KS 66043. n0cs@arrl.net

09/18/2021 | International Talk Like A Pirate Day

Sep 18-Sep 19, 1300Z-2200Z, K9P, Danville, IN. Hendricks County Amateur Radio Society. 14.262 7.212 3.812. QSL. Tom Hansen, 410 W US Highway 40, Clayton, IN 46118-9307. Fun event, talk like a pirate. Know yer port (QTH) and yer ship's name.

09/18/2021 | Titan Missile Museum

Sep 18, 1600Z-2020Z, KT7RC, Tucson, AZ. Tortolita Radio Club. CW: 7.040, 14.040 SSB: 7.200, 14.250 FT-8: 7.074, 18.100. Certificate. Request, certificate at, contact@tortolita-rc.com. No paper QSL's. Request certificate at contact@tortolita-rc.com. <https://tortolita-rc.com>

09/20/2021 | Wyatt Earp Fest

Sep 20-Sep 25, 0100Z-0100Z, W0E, Lamar, MO. Kilowatt Amateur Radio Club. 14.250. QSL. Kilowatt ARC (K0KWC), 700 Hagney St., Lamar, MO 64759. kilowattarc@hotmail.com

09/24/2021 | Speculator Applefest

Sep 24-Sep 26, 1200Z-1200Z, W2H, Speculator, NY. Hamilton County Radio Club. 3958 mhz 7230 mhz 3531 mhz 7031 mhz. QSL. Peter Weaver, NYS Rt 8, Lake Pleasant, NY 12108. www.hamcoarc.org

09/25/2021 | Covered Bridge Special Event

Sep 25, 1200Z-2200Z, K1SV, Arlington, VT. Southern Vermont Amateur Radio Club. 146.520 28.333 14.318 7.245. Certificate & QSL. Alden Jones, IV, 222 Northside Dr., Bennington, VT 05201. www.sovarc.org

09/25/2021 | LCARA - Somernites Cruise September

Sep 25, 1200Z-1800Z, K4S, Somerset, KY. Lake Cumberland Amateur Radio Association. 14.210 14.220 14.230 14.240. QSL. Wanda Munsey, 600 W. Hwy 837, Nancy, KY 42544. lcara.net

09/25/2021 | Masonic Lodges on the Air (CQ More Light)

Sep 25, 1400Z-2200Z, K1I, Reisterstown, MD. Ionic Lodge #145. 3.825 7.200 14.250 21.300. Certificate & QSL. Mark Rauen , C/O Ionic Lodge #145, 85 Main Street , Reisterstown, MD 21136. Promoting public awareness of ham radio and Freemasonry with fraternal greetings among Hams, Freemasons and Masonic Lodges around the world. www.gemeny.com/AA3NM/CQ-MoreLight.html

09/25/2021 | Net Operator Recognition Event

Sep 25, 1600Z-2200Z, W4YK, Hendersonville, NC. Blue Ridge Amateur Radio Club. 14.238 MHz. QSL. David Day, 11 Mountain Spring Dr, Hendersonville, NC 28739. This event is to recognize and thank those individuals who have served as net operators for their local amateur radio clubs. radioclub.org

09/25/2021 | North America's Most Westerly Contiguous Highway Point

Sep 25-Sep 26, 1900Z-1900Z, KL7HOM, Anchor Point, AK. South Peninsula Amateur Radio Club. 14.249 18.149 7.249 14.049. QSL. Thomas Kerns, 1189 Cook Way, Homer, AK 99603. <https://www.qrz.com/db/KL7HOM>

09/25/2021 | Peshtigo Fire 150th Anniversary

Sep 25, 1200Z-2100Z, K9P, Peshtigo, WI. Marinette & Menominee Amateur Radio Club. 14.305 14.055 7.285 7.080 . Certificate. Arden D. Nelson, 329 Brown Ave., Peshtigo, WI 54157. www.w8pif.com

09/25/2021 | SENRC 85th Anniversary

Sep 25-Sep 26, 1521Z-1519Z, N0N, Lincoln, NE. Southeast Nebraska Amateur Radio Club. 7.180 14.230. Certificate & QSL. Charles Bennett, PO Box 67181, Lincoln, NE 68506. senebrradioclub@gmail.com or <https://www.facebook.com/SENRC>

09/25/2021 | VOA Bethany Station 77th Anniversary

Sep 25-Sep 26, 1600Z-2100Z, WC8VOA, West Chester, OH. West Chester Amateur Radio Association. 14.268 7.268. Certificate & QSL. West Chester ARA - QSL Manager, P.O. Box 913, West Chester, OH 45071. QSL Direct or via the bureau, please look at our QSL policy on our website or QRZ. An electronic certificate will be available for download after the event is over, it might take up to 24 hours after the event to get your certificate. Details will be posted on our website: www.wc8voa.org

One by one call special events:

K4A, K4P, N2F, N3M, N3U, N7F, W2T, W3M, W4D 911 memorial calls

W6A, W6B, W6C, W6D, W6E, W6F, W6G, W6H, W6I, W6J, W6K, W6L, W6M, W6O, W6P, W6Q, W6R, W6S, W6T, W6U, W6V Route 66 Calls

K0B	10	4SQRP GROUP BRUTUS BASH
W4B	2	Bonnaroo Music and Arts Festival
W4B	6	Bristol Rhythm & Roots 20th
W1C	17	Chowdercon 2021 - QRPfest
N4S	25	East Tennessee Hamfest 2021
N5R	24	First Responders
W1G	16	FM Sprint
N9D	10	Indiana Parks On The Air (INPOTA)
K4B	16	Kentucky Bourbon Festival
W3B	10	Lancaster Hot Air Balloon Festival
N8L	1	Leukemia Awareness Month
W1A, N6A, N1T, W1B	8	Northeast HamXposition
W0M	11	NPOTA RV04 Mississippi River Activation
K8K, N8T	8	Ohio State Parks on the air
W0R	11	Operation Underground Railroad
K4P	23	Prepper Camp
K7G, W7J, W7P	15	Salmon Run contest
W4Y	23	Savannah River Academy Get on the Air Event
N7V	17	Silver State Classic Challenge
K4T	4	Tennessee QSO Party
K5T, K5Y, N5C	18	Texas QSO Party
W8T	17	Tompkins Steam Festival
W7M	17	WA State QSO Party
W1M	18	WHOA/ScoutsBSA camp

ARRL Free RF Exposure Calculator

Since the FCC no longer automatically exempts amateur radio stations from testing radio frequency exposure limits, the ARRL has developed a way to assist hams in being in compliance. ARRL is providing an online calculator that will help amateurs establish safe distances people must be to prevent RF exposure from their station.

The calculator takes into account a controlled or uncontrolled location. The site provides simple instructions and offers helpful information. Amateurs can then make a hard copy (print) for their records.

<http://arrl.org/rf-exposure-calculator>

Thanks Tom W3TOM for the information

Free Classes

I am starting a free Technician Class course on Zoom beginning Thursday, September 9 and running for 11 sessions. Sessions will start at 6:30 and run 3 hours. No charge, of course. These are the classes sponsored by the National Electronics Museum that we have been holding for years. Those wishing to sign up should email me at roland.anders@comcast.net.

Thanks,
Rol Anders, K3RA

FCC News

We get a break

FCC amateur radio application fees won't start till 2022 was revealed in the meeting with Volunteer Examiner Coordinators (VECs). The FCC is making necessary changes to the Universal Licensing System (ULS) software before it starts collecting fees from amateur applicants.

The \$35 application fee will apply to new, modification (upgrade and sequential call sign change), renewal, and vanity call sign applications; not to administrative update applications, (licensee's name, mailing, or email address change

"Once the FCC application fee takes effect, new and upgrade applicants will pay the exam session fee to the VE team; they'll pay the \$35 application fee directly to the FCC using the FCC Pay Fees system. When the FCC receives the examination information from the VEC, it will email a link with payment instructions to each successful candidate who then will have 10 days from the date of the email to pay. FCC Pay Fees system is at, https://apps2.fcc.gov/Batch_Filer/login.cfm.

After the fee is paid and the FCC has processed an application, examinees will receive a second email from the FCC with a link to their official license. The link will be good for 30 days. Licensees also will be able to view, download, and print official license copies by logging into their FCC ULS account. The FCC no longer provides printed licenses.



The FCC's Emergency Connectivity Fund (ECF) is a program to help schools and libraries provide remote learning. For information on eligibility and the application form visit

<https://www.fcc.gov/emergency-connectivity-fund>.

Hams in Action

Bill Scott K6PKL spends hours on the radio every day. In 40 years of being an amateur radio operator, he has communicated with people everywhere, and connected to friends around the United States.

In June 2021, he received a phone call and recognized the voice on the other end. “It was all kind of skewed and everything. I thought it was a prank call at first, he said, ‘You are an amateur radio operator,’ and I said ‘Yeah’, then it all started coming together,” explained Scott. His ham radio friend, Skip Kritcher, K7ZAA, 500 miles away in Myrtle Point, Oregon dialed Bill’s number by mistake. Kritcher was on the floor and in need of help.

“I couldn’t see the numbers too good on the cell phone and I wound up pushing the button and calling Bill,” explained Kritcher.

Scott’s wife Sharon, a retired nurse of nearly 60 years, quickly realized Kritcher was having a stroke. “The speech that he had was slurred and my husband couldn’t seem to keep him on task, he was skipping all over and confused,” she explained.

“I was nervous because I didn’t want to lose my friend,” said Scott.

The line dropped, and the Scotts called 9-1-1. The couple had been to Kritcher’s house before and knew where to direct first responders to his house. A family member of Kritcher told the Scotts their quick actions saved his life. Kritcher still has impaired vision and is recovering from his stroke. Both he and Scott continue to communicate through their ham radios when they can.

“Just a miracle that he called the wrong number and he got us and we were able to do something to help him,” said Sharon Scott.

https://sacramento.cbslocal.com/2021/08/15/bill-scott-skip-kritcher-ham-radio-life-saved/?fbclid=IwAR2gblJvh2E3pm7pkVlkmF-tHOA_lapT795IG5zD02LWPGC0QP6HBxNmLRQ

BE FAST

Stroke signs

Balance loss

Eyes blurred or not focusing

Face droops

Arm (or leg) weak or numb

Speech slurred or not coherent

Time note the time it started



Charles County Amateur Radio Club Meeting Minutes

June 4, 2021

Officers Present:

President – Bob Curran NW3M
Vice President – Unable to Attend
Treasurer – Pamela Humbert KB3SWS
Activities – Jeff Humbert KB3SPH
Secretary – Charles Hallock AA3WS

Visitors:

Nathan Daetwyler
Rory Daetwyler

Members Present:

Jim Dunn W3JTD
John Kohansby KC3PMJ (Zoom)
Michelle Sack N3YRZ (Zoom)
Bill Luyster W8BL
Joe Boswell – KB3HNP
Terry Venincasa – KC3ELY

Meeting opened 1910 Hours.

President Bob Curran NW3M opened the Meeting at the Marbury Baptist Church Social Hall. The meeting was also displayed on Zoom. Bob welcomed the guest and members. Bob advised the members and guest that the next meeting would be at the Marbury Baptist Church Social Hall on September 3, at 1900 Hours. Additionally he advised Net Control Operators are need for the Weekly Club Net. He advised he was taking orders for the Three Element Quad Antenna Club Project to be build at the upcoming Connector Workshop.

Charles AA3WS gave a demonstration on the effects of antenna lengths and ground plains on the SWR of vertical antennas.

Treasurer:

Pamela Humbert KB3SWS, gave the August Treasurer's Report. The August's Treasurer Report was approved.

Activities Manager:

Jeff Humbert KB3SPH reported on the following upcoming activities:

3 Sep 2021 – Monthly CCARC Meeting at 7:00 PM at Marbury Baptist Church Social Hall preceded by a VE test session.

19 September 2021 – Connector Workshop - Nanjemoy Creek Environmental Education Center (NCEEC) – 1:00 PM to 5:00 PM – The sixth annual event, hosted by Pam and Jeff, will include lessons on building connectors with Anderson Power Poles, that can be used with various types of equipment. Additionally, this year's theme will be "Solar Sunday." Special "Show and Tell" presentations will be given by Kato, Jeff and Steven Keller – KC3DSO, and feature backpack portable, back yard portable and whole house solar power systems.

Secretary:

Minutes for the July's Meeting are published in the Monthly New Letter. The July Minutes were approved.

Charles advised the Church has been reserved for September and October Meetings.

Old Business

None.

New Business

President Bob requested the Clubs interest in participation in the MDC QSO Party. After discussion no consensus could be reached.

President Bob suggested the opportunity for a special event station celebrating the October 28, 20th anniversary of clocks flown in opposite directions around the Earth proving the Einstein's Theory of Relativity and that weekend is the 21st anniversary of the Southern Maryland Astronomical Society.

The LaPlata Train Station Museum is interested in Morse code demonstrations. Bob KB3KOW, is spearheading this activity and needs help.

Members:

Bill Luster W8BL and Bob Denny N3BD have become VE's.

Michelle advised of an upcoming Ham RV Talk. The particulars are in the Newsletter.

Jeff advised ARRL has published a new "RF Calculator" to assist in RF exposure testing.

Closing:

A motion was made and seconded to close the meeting. The motion passed at 2007 Hours.

Charles Hallock AA3WS

Secretary



The Wide Area Ragchew Session

The Saint Mary's County Amateur Radio Association is hosting a monthly, informal ragchew session via Zoom for hams in the surrounding counties. The idea is to just get together to chat about what's going on, activities, etc. 2nd Thursday of every month 7:30 PM Eastern Time

AGENDA:

- Everyone is invited and welcomed from anywhere in the MDC area (southern Maryland, Northern Neck, eastern shore of Maryland, etc.)
- - Open chat – who is doing what, club news from all areas, how can we work together better to keep ham radio a growing, viable hobby, sharing of news about upcoming ham events, meet new people!
- Please keep all discussions related to ham radio activities!

JOINING THE GROUP (there are 3 different ways to join in on the meeting):

1 – Click on this QUICK LINK:

<https://us02web.zoom.us/j/8673965998?pwd=Q2IUL05PTVB3RnEvUkZPNmlKUFJ3QT09>

2 – Open up the ZOOM app on your computer or device and:

Select 'Join Meeting' button and type in the meeting ID and password:

Meeting ID: 867 396 5998 Meeting Password: 1460464

3 – Use your regular telephone (no computer needed, voice only, no video):

Dial 1-301-715-8592 (US) – Follow the voice prompts... enter the Meeting ID followed by the # (pound) symbol; then enter your participant ID (if applicable) followed by #; then enter the meeting password followed by #

Contact information: Rob Hoyt, N2OMC – SMCARA President/ host robhoyt32@yahoo.com

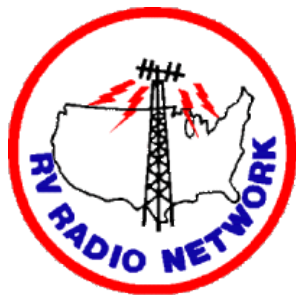

RV Radio Network nets
HF 2000 EDT daily ~7.264



EchoLink Thursdays 2100 EDT
SELINK

ANSWERS

Answers to practice questions 1 C 2 C 3 B 4 B

WANT ADS, FOR SALE, &

PUBLIC SERVICE ANNOUNCEMENTS:



**Southern Maryland
Astronomical Society**

Explore the night sky with us at our observatory, or use your own telescope.

New to astronomy? We'll help you learn.

For information, visit us at <http://smas.us>

TrotSar Mounted Search Team
21218 Dorsey Spring Place
Germantown, MD 20878
Pete KC3SBN Commander

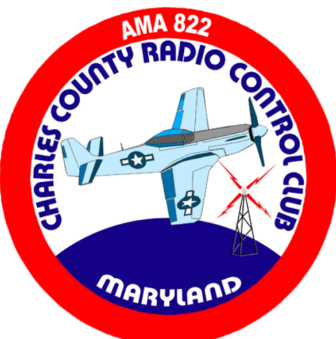

**AMA 822
CHARLES COUNTY RADIO CONTROL CLUB
MARYLAND**

Interested in joining the fascinating hobby of RC airplanes?

The Charles County Radio Control Club is ready to help you get started.

Visit us on the web: charlescountyrcc.com



Smallwood Camera Club

Open to all skill levels and photographic interests.



email: SmallwoodCameraClub@gmail.com



**EAST COAST
AMATEUR RADIO SERVICE**

1968 - 2018 Leading the Way Into the Next 50 Years 2018 - 2068



Net Operations occur daily on 7.255 MHz (LSB).
Weekday operations 7:30 am to 2:00 pm
Weekend operations 8:00 am to 12:00 pm, East Coast time
<http://www.ecars7255.com/FrontPageLinks/ECARSOrganization/info.htm>

Meetings, nets, & contacts

- First Friday- Monthly meeting @ 7 PM/1900
- Net-Wednesdays 8:30 PM local 147.195 MHz, + 600 , PL 156.7 EchoLink KB3KOW-R
- PO BOX 169, La Plata, MD 20646
- President: Bob Curran NW3M flyingham@verizon.net
- Vice-president: Bob Davidson rdavidson@aceweb.com
- Secretary: Charles Hallock AA3WS selbynet@hotmail.com
- Treasurer: Pam Humbert KB3SWS *humbertpj@gmail.com*
- Activities: Jeff Humbert KB3SPH humbert1js@gmail.com
- Newsletter Michelle Sack N3YRZ msack@verizon.net
- VE Coordinator Bob Curran NW3M



We're on the web
<http://k3smd.net>

Leave laughing

